

Hybrid L S21

Centralised ventilation unit for small apartments

- Sound-insulated casing
- CO2 sensor: Optional
- PM2.5 sensor: Optional

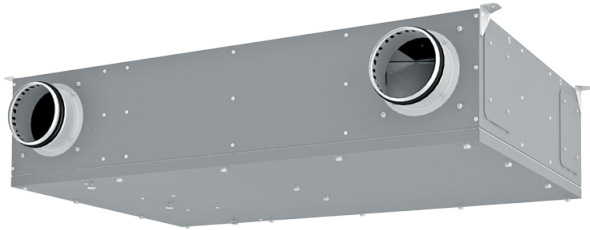

	Unit of measurement	Hybrid L S21
Minimum supply voltage	V	230
Maximum supply voltage	V	230
Power supply frequency	Hz	50/60
Transported air temperature (max)	°C	40
Transported air temperature (min)	°C	-25

Dimensions

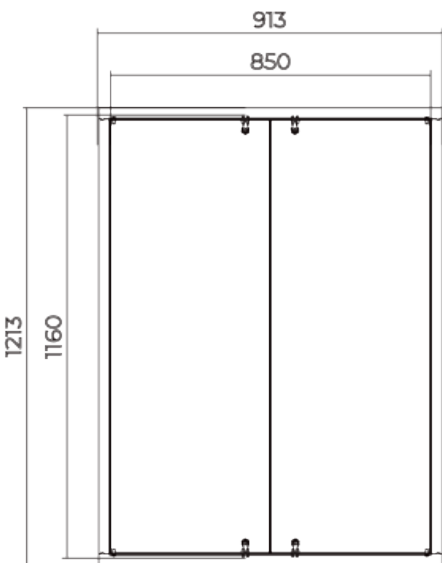
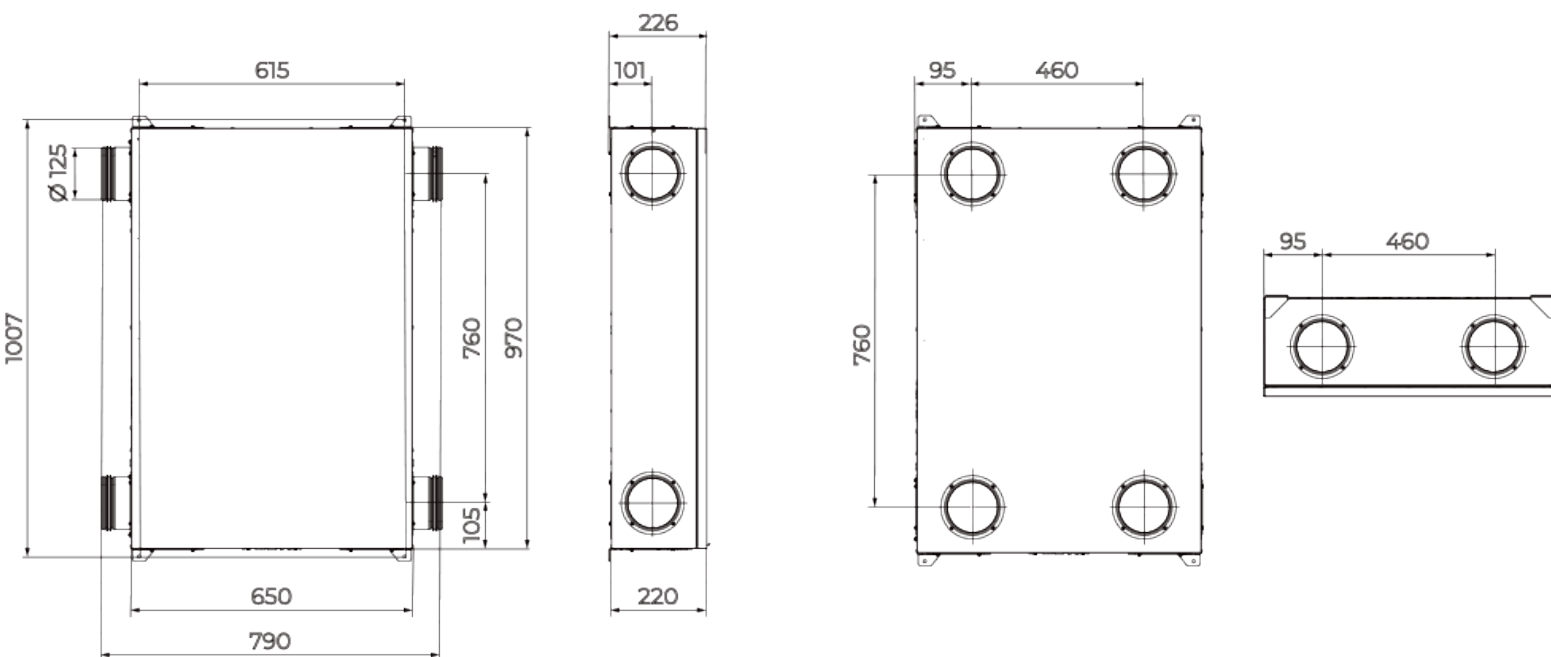

РЕВИЗИОННЫЕ ДВЕРЦЫ
RTMS2 850x1160